

VEO-SWH44

SWITCHER

HDMI 2.0 4x1 18GPBS Switcher with audio De-Embedder
and RS-232 control



USER MANUAL

INDEX

1. IMPORTANT REMARK	3
2. IMPORTANT SAFETY INSTRUCTIONS	3
3. INTRODUCTION	5
4. PACKAGE CONTENTS	5
5. PANEL DESCRIPTION	6
5.1. <i>Front Panel</i>	6
5.2. <i>Rear Panel</i>	7
6. CONNECTION AND INSTALLATION	8
7. RS-232 CONTROL.....	9
8. APPLICATION DIAGRAM	10
9. TECHNICAL SPECIFICATIONS.....	11

1. IMPORTANT REMARK



WARNING: SHOCK HAZARD - DO NOT OPEN
AVIS: RISQUE DE CHOC ÉLECTRIQUE - NE PAS OUVRIR



The lightning flash with arrowhead symbol, within an equilateral triangle, is intended to alert the user to the presence of uninsulated “dangerous voltage” within the product’s enclosure that may be of sufficient magnitude to constitute a risk of electric shock to persons.



The exclamation point within an equilateral triangle is intended to alert the user to the presence of important operating and maintenance (servicing) instructions in the literature accompanying the appliance.

WARNING (If applicable): The terminals marked with symbol of “” may be of sufficient magnitude to constitute a risk of electric shock. The external wiring connected to the terminals requires installation by an instructed person or the use of ready-made leads or cords.

WARNING: To prevent fire or shock hazard, do not expose this equipment to rain or moisture.

WARNING: An apparatus with Class I construction shall be connected to a mains socket-outlet with a protective earthing connection.

2. IMPORTANT SAFETY INSTRUCTIONS

1. Read these instructions.
2. Keep these instructions.
3. Heed all warnings.
4. Follow all instructions.
5. Do not use this apparatus near water.
6. Clean only with dry cloth.
7. Do not block any ventilation openings. Install in accordance with the manufacturer’s instructions.

8. Do not install near any heat sources such as radiators, heat registers, stoves, or other apparatus (including amplifiers) that produce heat.
9. Do not defeat the safety purpose of the polarized or grounding type plug. A polarized plug has two blades with one wider than the other. A grounding type plug has two blades and a third grounding prong. The wide blade or the third prong are provided for your safety. If the provided plug does not fit into your outlet, consult an electrician for replacement of the obsolete outlet.
10. Protect the power cord from being walked on or pinched particularly at the plugs, convenience receptacles, and at the point where they exit from the apparatus.
11. Only use attachments/accessories specified by the manufacturer.
12. Unplug the apparatus during lightening sorts or when unused for long periods of time.
13. Refer all servicing to qualified personnel. Servicing is required when the apparatus has been damaged in any way, such as power supply cord or plug is damaged, liquid has been spilled or objects have fallen into the apparatus, the apparatus has been exposed to rain or moisture, does not operate normally, or has been dropped.
14. Disconnecting from mains: Switching off the POWER switch all the functions and light indicators of the amplifier will be stopped, but fully disconnecting the device from mains is done unplugging the power cord from the mains input socket. For this reason, it always shall remain readily operable.
15. Equipment is connected to a socket-outlet with earthing connection by means of a power cord.
16. The marking information is located at the bottom of apparatus.
17. The apparatus shall not be exposed to dripping or splashing and that no objects filled with liquids, such as vases, shall be placed on apparatus.

NOTE: This equipment has been tested and found to comply with the limits for a Class A digital device, pursuant to part 15 of the FCC Rules. These limits are designed to provide reasonable protection against harmful interference when the equipment is operated in a commercial environment. This equipment generates, uses, and can radiate radio frequency energy and, if not installed and used in accordance with the instruction manual, may cause harmful interference to radio communications. Operation of this equipment in a residential area is likely to cause harmful interference in which case the user will be required to correct the interference at his own expense.



WARNING: This product must not be discarded, under any circumstance, as unsorted urban waste. Take to the nearest electrical and electronic waste treatment centre.

NEEC AUDIO BARCELONA, S.L. accepts no liability for any damage that may be caused to people, animal or objects due to failure to comply with the warnings above.

3. INTRODUCTION

Ecler VEO-SWH44 is a professional 4x1 HDMI 2.0 switcher. It supports HDR formats and HDMI data rate up to 18Gbps, including 4K/UHD@60Hz video resolution with 4:4:4 chroma sampling. The control includes auto-switching feature, front panel buttons, RS-232 and IR with remote control. VEO-SWH44 is HDCP 2.2 compliant and it guarantees seamless integration for all applications that require latest 4K/UHD and HDR sources and displays.

Features:

- 4x1 Ultra High Definition source selector compliant with HDMI 2.0a standard
- Video formats up to 4Kx2K (4096x2160@60Hz YUV 4:4:4) and all HDMI 3D video formats.
- Supports HDR and 3D content
- HDCP 2.2/1.4 Compliant
- Supports 36 bit Deep Color
- Supports smart EDID audio management (Auto/2CH/5.1CH/7.1CH selectable)
- Supports PCM, Dolby TrueHD, DTS-HD Master Audio up to 7.1CH
- Supports Audio Return Channel (ARC)
- Digital and analog audio output
- RS-232 Control
- Supports up to 18Gbps video data rate

4. PACKAGE CONTENTS

- 1 x HDMI 4x1 Switcher
- 1 x 5V DC 1A International Power Supply
- 1 x IR RX cable
- 1 x Optical Adapter (for SPDIF audio output)
- 1 x HDMI 4x1 IR Remote

5. PANEL DESCRIPTION

5.1. Front Panel

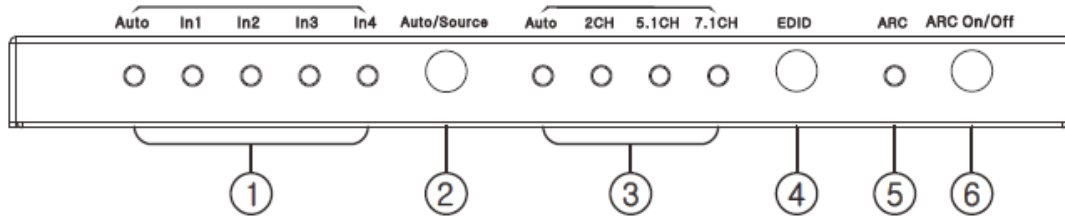

1. Source Selection LED Indicators
2. Source Selection Mode Button: Auto/Manual
 - Press this button for 2 seconds to select auto switching or manual switching mode. Under manual switching mode, press this button normally to select input port.
3. EDID Status LED
 - Auto mode corresponds to Display EDID
4. EDID Select Button
 - Press this button to select EDID mode Auto/2CH/5.1CH/7.1CH
5. ARC Status LED
 - This LED is lit when ARC is enabled successfully
6. ARC Activation Button

5.2. Rear Panel

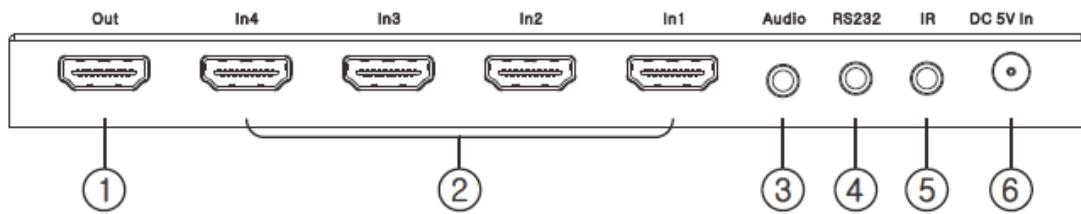

1. HDMI Output Port
2. HDMI Input Ports
3. Audio De-embedding Output
 - (Analog 3.5mm Stereo Minijack or Toslink Digital Output using the included adapter)
4. RS-232 port

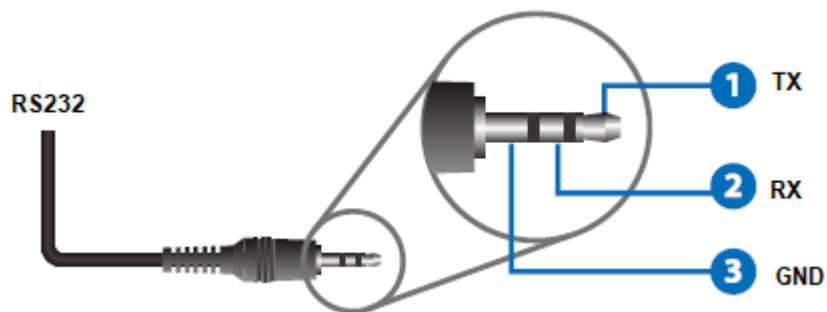

5. IR Port
 - Connect the included IR receiver to use IR remote control

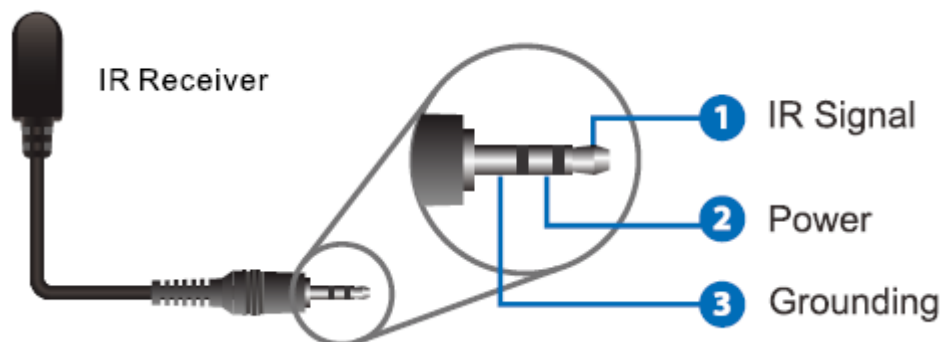











6. 5V DC Power Connector

6. CONNECTION AND INSTALLATION

1. Connect HDMI signal sources (such as PC, Blu-ray player, etc) to VEO-SWH44 HDMI input ports.
2. Connect VEO-SWH44 HDMI output port to display.
3. Connect Audio and Control devices if required.
4. Power up VEO-SWH44, display and sources.
5. In order to control VEO-SWH44 using the included IR remote, please connect IR Receiver to the corresponding port. The Remote functions are listed in the following table:



	<p>Press this button to enable or disable ARC function. ARC LED on front panel will be illuminated if ARC function is enabled successfully.</p>
   	<p>Press these buttons to select different EDID setting and corresponding LED on front panel will be illuminated.</p>
	<p>Press this button to select auto switching or manual switching mode.</p>
   	<p>Under manual switching mode, press this button to select input port.</p>

7. RS-232 CONTROL

VEO-SWH44 can be controlled by third party control systems using serial commands through the RS-232 minijack port on the back of the panel.

In order to control the device, serial protocol communication parameters need to be set as follows:

Baud rate:	19200
Data bits:	8
Parity:	None
Stop bit:	1

Source Selection

Input 1	A5 5B 02 03 01 00 01 00 00 00 00 00 F9
Input 2	A5 5B 02 03 02 00 01 00 00 00 00 00 F8
Input 3	A5 5B 02 03 03 00 01 00 00 00 00 00 F7
Input 4	A5 5B 02 03 04 00 01 00 00 00 00 00 F6

Audio Mode Switch

Audio Auto	A5 5B 03 02 01 00 01 00 00 00 00 00 F9
Stereo Audio2.0	A5 5B 03 02 02 00 01 00 00 00 00 00 F8
Dolby/DTS 5.1	A5 5B 03 02 03 00 01 00 00 00 00 00 F7
HD Audio 7.1	A5 5B 03 02 04 00 01 00 00 00 00 00 F6

Auto Switching Mode

ON	A5 5B 02 05 0F 00 00 00 00 00 00 00 EA
OFF	A5 5B 02 05 F0 00 00 00 00 00 00 00 09

ARC (Audio Return Channel)

ON	A5 5B 10 01 0F 00 01 00 00 00 00 00 DF
OFF	A5 5B 10 01 F0 00 01 00 00 00 00 00 FE

Device Information Query (e.g: No Devices Connected)

HDMI IN1	A5 5B 01 04 01 00 00 00 00 00 00 00 FA
HDMI IN2	A5 5B 01 04 02 00 00 00 00 00 00 00 F9
HDMI IN3	A5 5B 01 04 03 00 00 00 00 00 00 00 F8
HDMI IN4	A5 5B 01 04 04 00 00 00 00 00 00 00 F7
HDMI OUT	A5 5B 01 05 01 00 00 00 00 00 00 00 F9

8. APPLICATION DIAGRAM

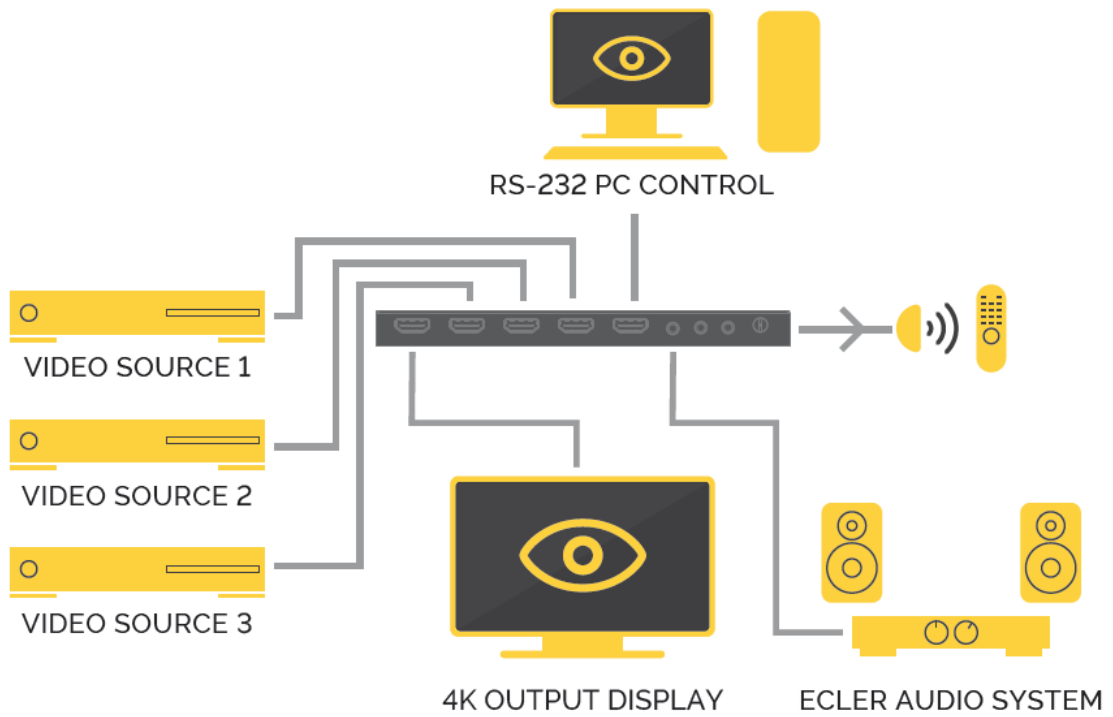

9. TECHNICAL SPECIFICATIONS

Supported Resolutions	4096x2160@24/25/30/50/60Hz, 3840x2160@24/25/30/50/60Hz, 2048x1080p 1080p@23.98/24/25/29.97/30/50/59.94/60Hz, 1080i@50/59.94/60Hz, 720p@50/59.94/60Hz, 576p, 576i, 480p, 480i
Colorspace	YCbCr, RGB
Chroma Subsampling	4:4:4, 4:2:2, 4:2:0
Color depth	8-bit, 10-bit, 12-bit
HDR	HDR10
Signal Bandwidth	18 Gbps
HDCP	2.2, 1.4 Compliant
Audio Formats	PCM 2Ch, LPCM 5.1, LPCM 7.1, Dolby Digital, DTS 5.1, Dolby TrueHD, DTS-HD Master Audio
Sample Rate	32kHz, 44.1kHz, 48kHz, 88.2kHz, 96kHz, 176.4kHz, 192kHz
Bitrate	up to 24-bit
HDMI Distance	up to 10 meters (33 feet) with Ecler VEO cables
Operating Temperature	0°C - 40°C / 32°F - 104°F
Humidity	20 - 90% RH (no condensation)
Power Consumption	2,5W Maximum
Power Supply	AC100~240V 50/60Hz Output: DC 5V/1A
Dimensions H x W x D	180mm x 85mm x 12mm (7.09" x 3.35" x 0.47")
Weight	300g (0.661 lbs)

All product characteristics are subject to variation due to production tolerances. **NEEC AUDIO BARCELONA S.L.** reserves the right to make changes or improvements in the design or manufacturing that may affect these product specifications.

Motors, 166-168 08038 Barcelona - Spain - (+34) 932238403 | information@ecler.com | www.ecler.com