

IC6

CEILING LOUDSPEAKERS

In-ceiling / In-wall Loudspeaker



PRODUCT OVERVIEW

With its discreet design, the IC6 2-way loudspeaker is the perfect option for 70/100 V and low impedance sound solutions. It mounts a 6.5" woofer and a 1" tweeter.

IC series provide excellent sound quality thanks to their infinite baffle philosophy and a top-performance high frequency transducer.

KEY FEATURES

- Two-way ABS speaker, 40 WRMS
- 6.55" woofer / 1" tweeter
- Built-in audio transformer for 70/100 V use
- Polypropylene woofer that resists heat and humidity
- Front grill may be removed for painting
- Aluminium front grill, rust-proof
- Clip-type input terminals and low impedance / high impedance power tap selector
- Cutting and painting templates included
- Support system with 3 rotating tabs
- Available in black (RAL9005) or white (RAL9010) finish
- EASE Win file available



APPLICATIONS

- Corporate and residential buildings
- Commercial premises
- Leisure centres
- Sound reinforcement in clubs, bars, etc.
- Health and sports centres
- Meeting and conference rooms
- 5.1 and 7.1 surround systems
- Auditoriums, museums

TECHNICAL SPECIFICATIONS

IC6

System	
Effective frequency range ¹	75 Hz - 20 kHz (-10dB)
Coverage angle ²	145°
Power handling	40W RMS / 160W Peak
Sensitivity ³	93dB (1W/1m)
Maximum SPL ⁴	109dB continuous / 115dB peak
Power options	100V: 2,5 / 5 / 7,5 / 15W 70V: 1,25 / 2,5 / 3,75 / 7,5W
Recommended amplifier	80W
Transducers	
Ways	2-way, full range
Low Frequency Driver	6.5" woofer
High Frequency Driver	1" tweeter
Nominal impedance	8Ω
Physical	
Connection type	Clip-type input terminals
Installation options	In-ceiling, in-wall
Grille material	Aluminium rust proof
Mounting system	3 rotating tabs
Finished color	Black (RAL9005) or White (RAL 9010)
External diameter	204mm / 8.03"
Internal diameter	178mm / 7.00"
Recommended cut out diameter	180mm / 7.40"
Required depth	>73mm / 2.87"
Ceiling thickness	5mm / 0.19" min and 20mm / 0.78" max
Weight	1,5 kg. / 3.30 lb.
Pieces per box	2 units
Shipping dimensions(WxHxD)	240 x 250 x 220mm / 9.4" x 9.8" x 8.66"
Shipping weight	1,90 kg. / 4.18 lb.

¹10dB below the sound pressure level at specified sensitivity

²6dB below the sound pressure level than that at the direction of maximum level, Max. angle between 1 kHz and 4 kHz.

³Measured on-axis, far field and referenced to 1 meter by inverse square law. Average from 100 Hz to 10 kHz.

⁴Calculated from sensitivity and power handling specifications, exclusive of power compression

FREQUENCY RESPONSE ON-AXIS

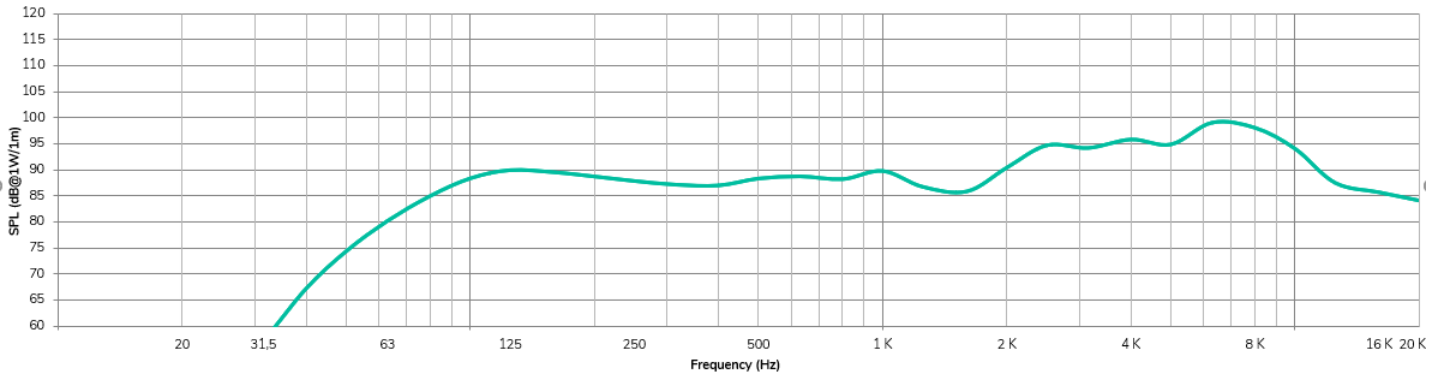

POLAR DIAGRAMS

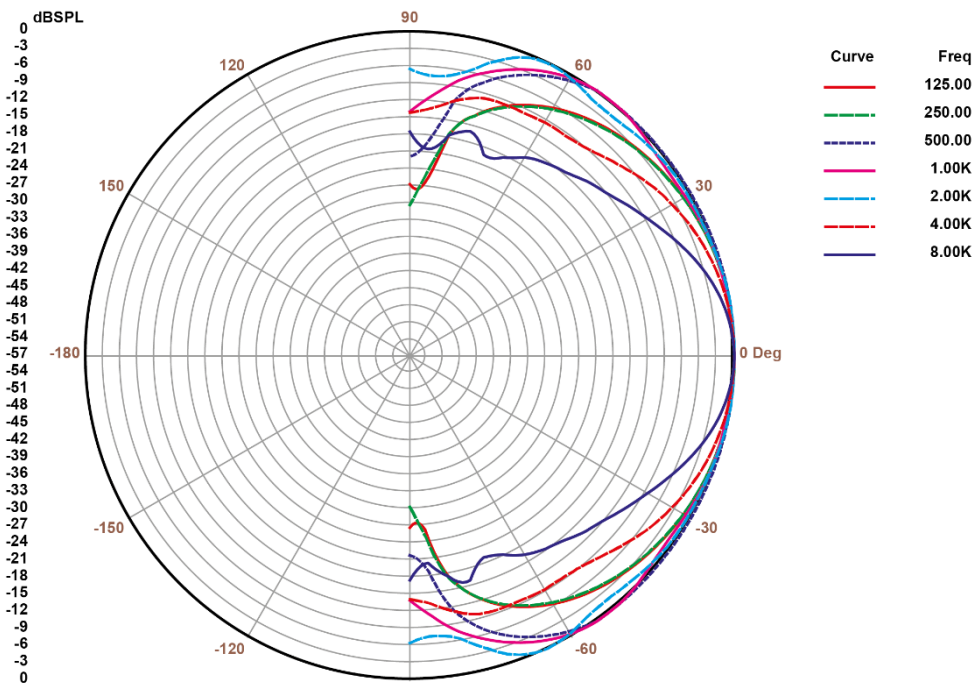

MECHANICAL DIAGRAMS

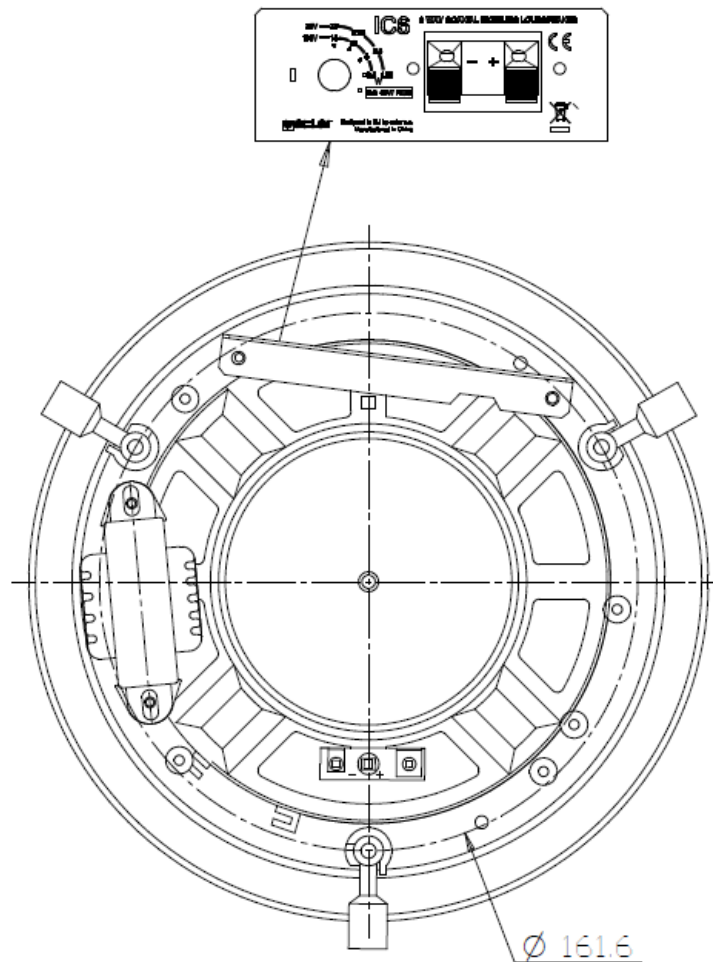
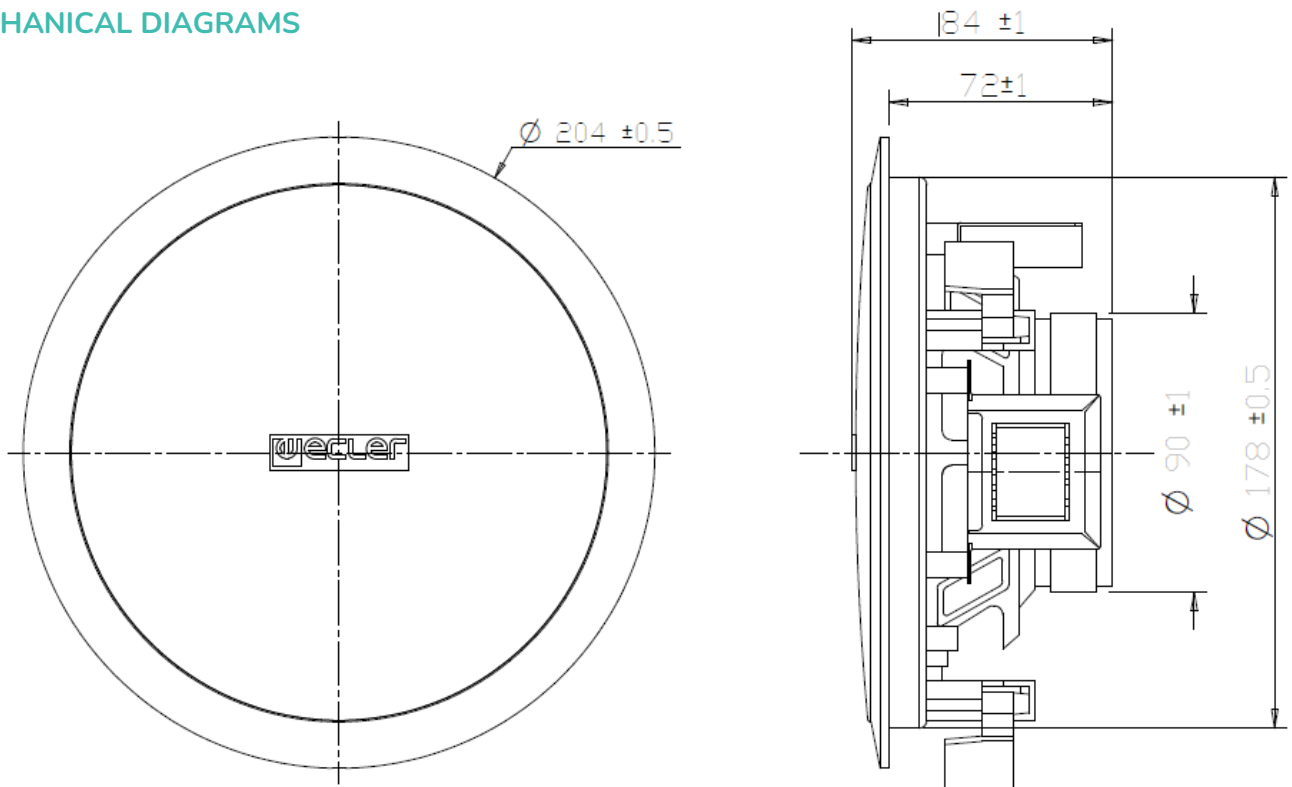

A&E SPECIFICATIONS

The in-ceiling installation loudspeaker shall be a 2 way ABS speaker, 6,5" woofer + 1" tweeter, suitable for 70/100 V line or low impedance installations. The power handling should be 40 W RMS at a rated impedance of 8 Ω with a peak power handling of 160 W. It shall include a line transformer with options for 15 W, 7.5 W, 5 W and 2.5 W in 100V line and 7.5 W, 3.75 W, 2.5 W and 1'5 W in 70V line, including an 8 Ω connection.

The effective frequency range shall be from 75 Hz to 20 kHz. The sensitivity shall be 93 dB, and the peak continuous sound pressure level shall be 109dB. The covered angle shall be 145°.

The enclosure shall be made of ABS plastic and the grill shall be made of rust proof aluminium. It shall come available in white (RAL9010) and black (RAL9005) colour. Mounting of the speaker into the ceiling shall be possible using its 3 rotating tabs. Connection to the amplifier shall be made via clip-type input terminals.

The loudspeaker shall have an external diameter of 204 mm, the required depth for installation shall be major than 73 mm and the weight shall not exceed 1'5 kg. The cut-out diameter shall be 180 mm. It shall be available data files that can be used with EASE and EASE ADDRESS acoustic simulation software.

The loudspeaker shall be the ECLER IC6.



All product characteristics are subject to variation due to production tolerances. **NEEC AUDIO BARCELONA S.L.** reserves the right to make changes or improvements in the design or manufacturing that may affect these product specifications.

For technical requests address to your supplier, distributor or fill the contact form in our website, at [Support / Technical Request](#).

Motors, 166-168 08038 Barcelona - Spain - (+34) 932238403 | information@ecler.com | www.ecler.com